

DORSI 1D

A

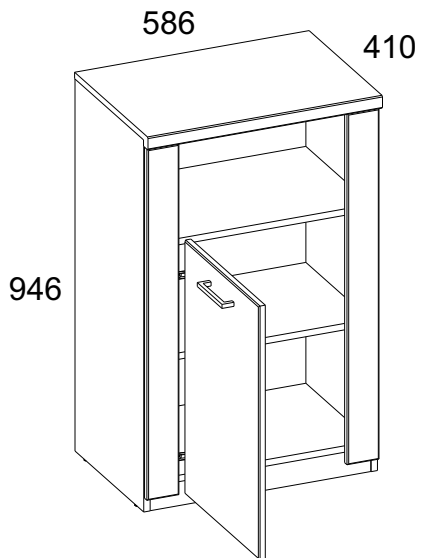

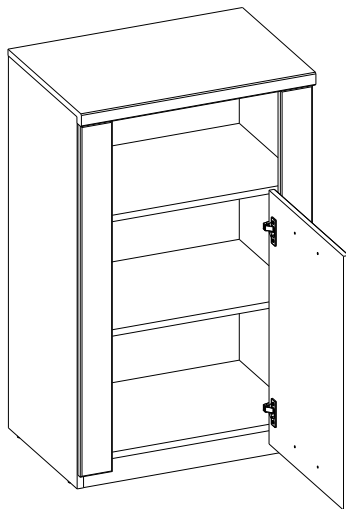



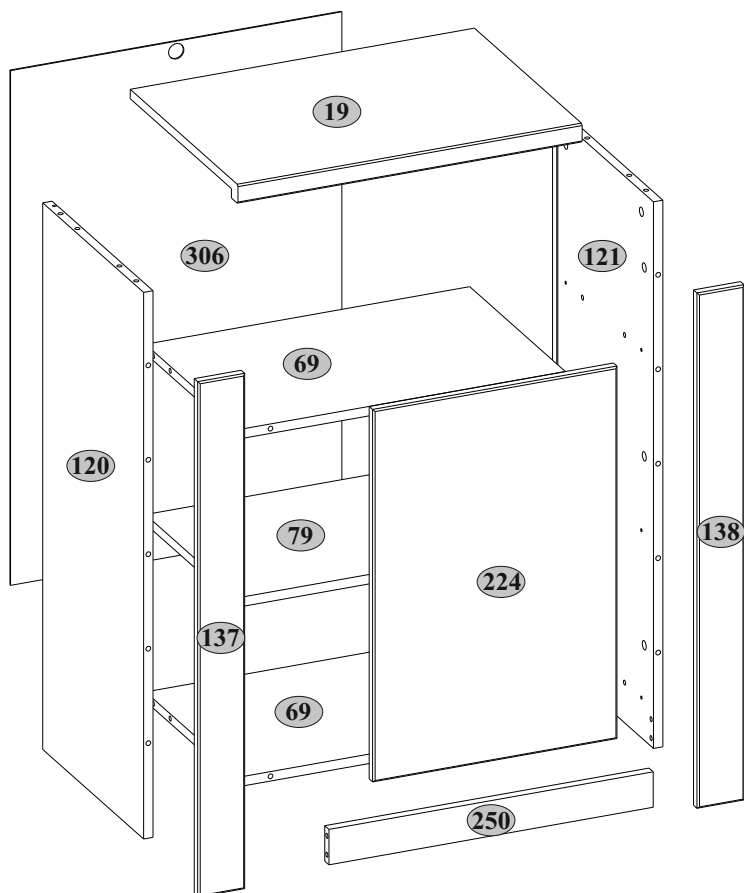



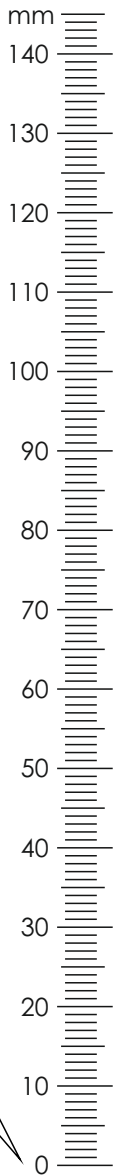



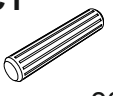
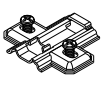

B





	L, mm	B, mm	H, mm	Q	
19	586	410	32	1	1/1
69	552	364	16	2	1/1
79	552	356	16	1	1/1
120	926	384	16	1	1/1
121	926	384	16	1	1/1
137	873	80	16	1	1/1
138	873	80	16	1	1/1
224	416	631	16	1	1/1
250	552	60	16	1	1/1
306	872	564	2,5	1	1/1

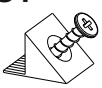

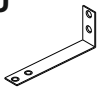
A1  7x34 22	A2  Ø15x12 22	B5  10x50 1	C1  8x35 20
D1-5  2	E15  2	H58  1	N1  4
P5  4	R3  3x20 4	R23  6,3x13 4	R32  4x27 2
R102  3,5x16 6	S1  8	S5  Ø18 8	S11  Ø8 2
U  130x35x15 1			

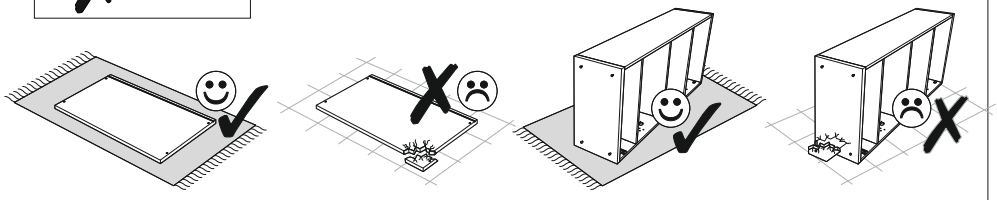
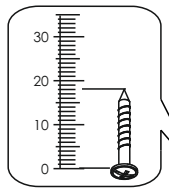
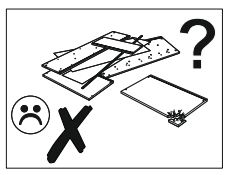
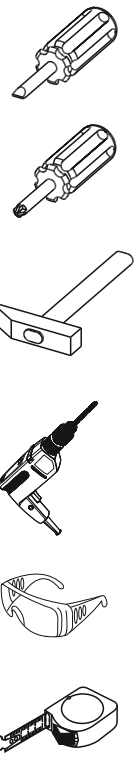

1

A1



7x34

C1

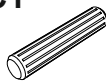

8 8x35

N1



4

P5



4

4

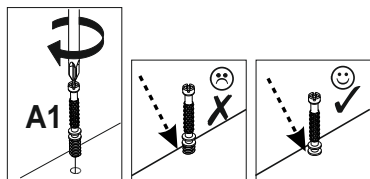
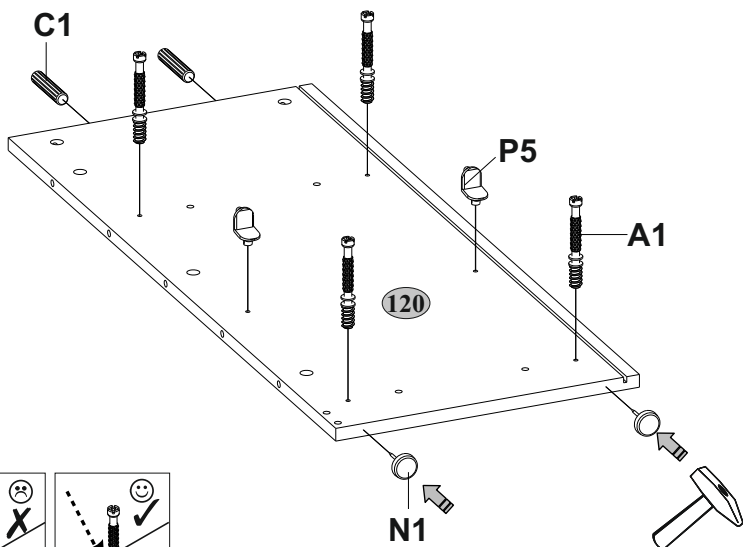
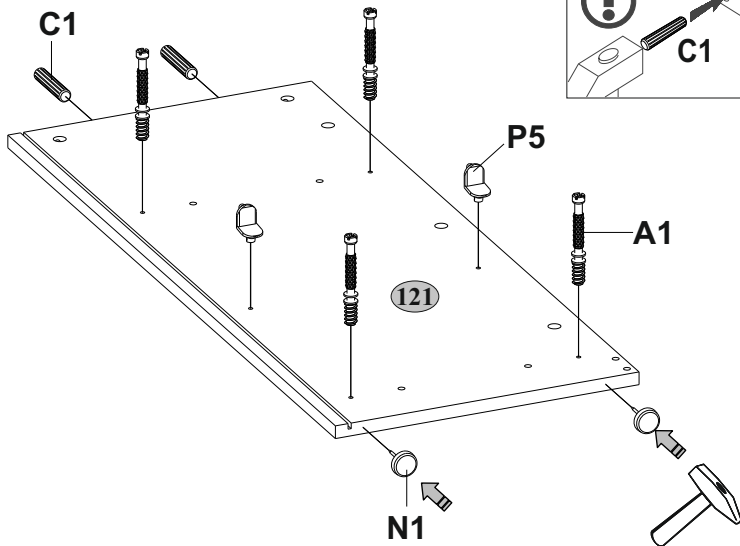

2

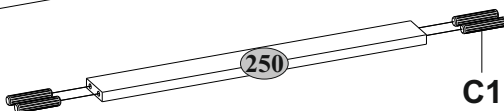
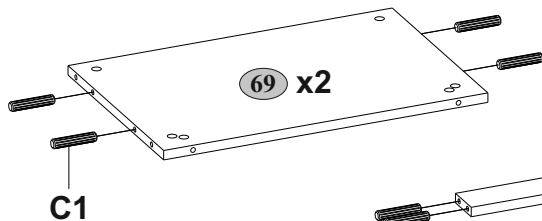
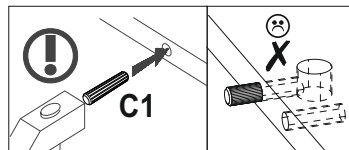
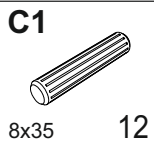

3

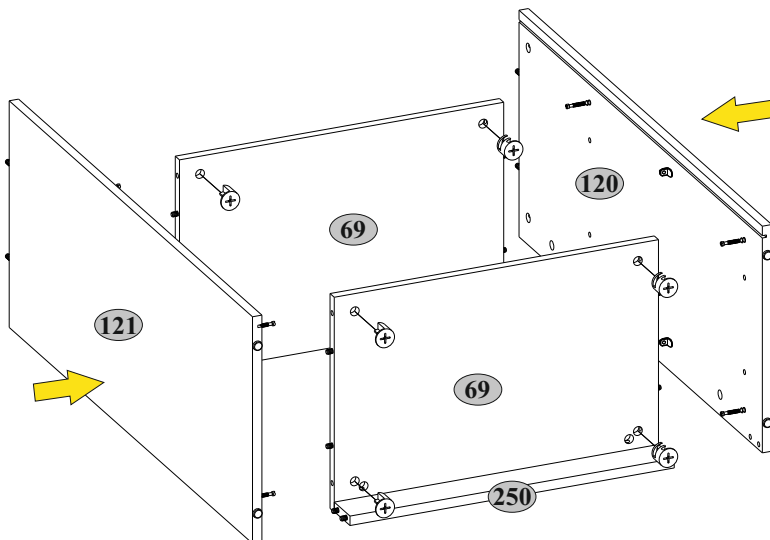
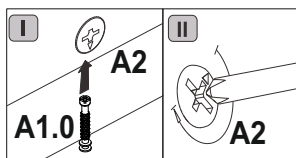
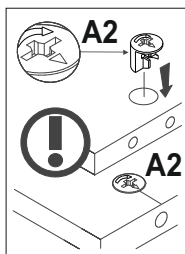
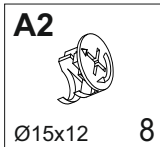

4

A1

7x34

4

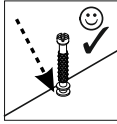
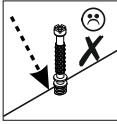
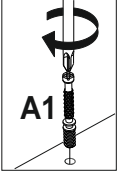
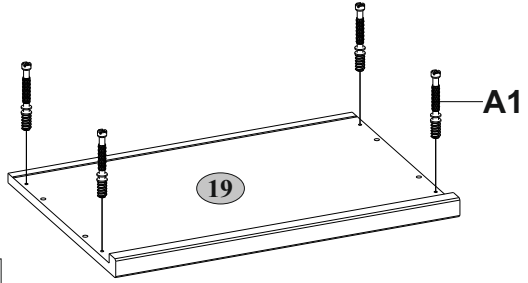

5

A2

Ø15x12

4

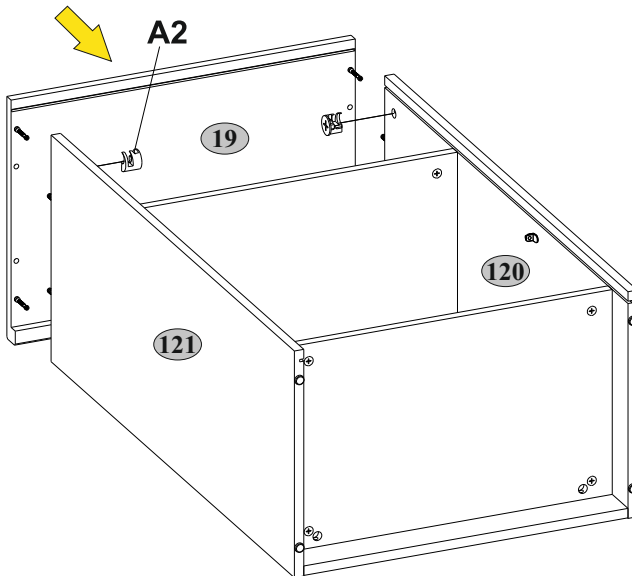
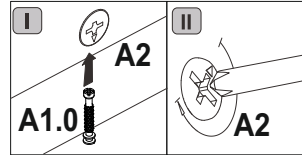
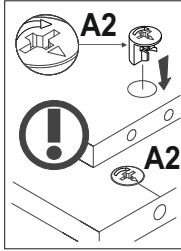

6

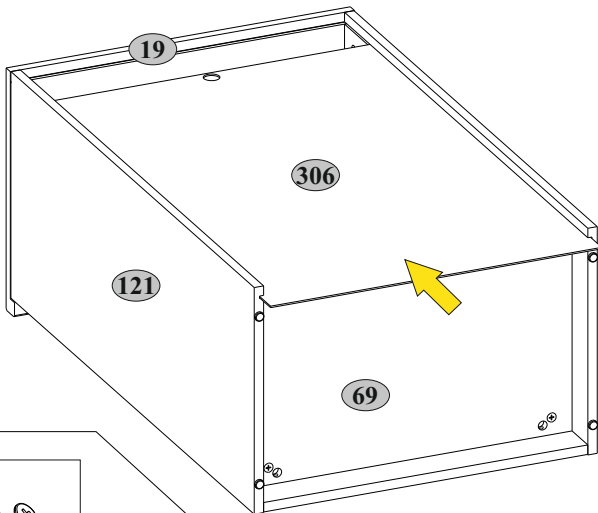

7

R3

3x20



4

S1



8

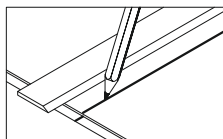
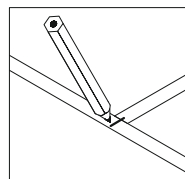
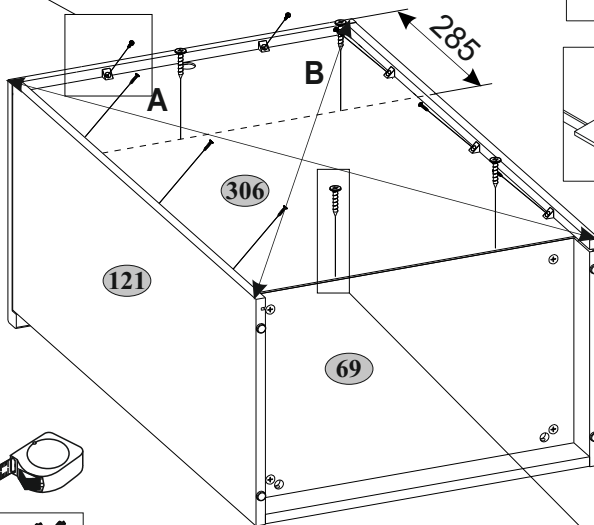
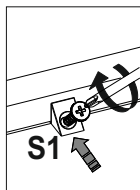

A=B

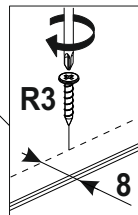
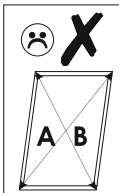

8

A

A1



7x34

10

D1-5

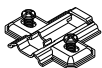

2

R23



6,3x13

4

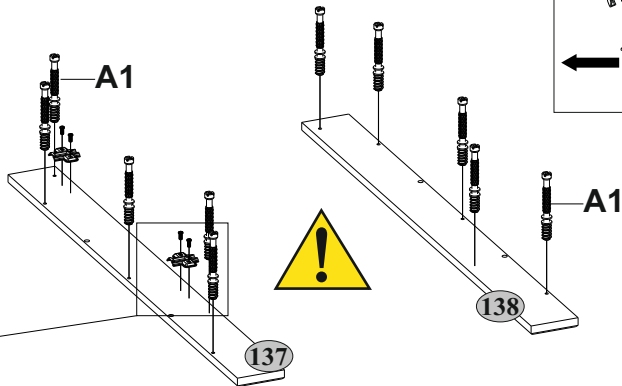
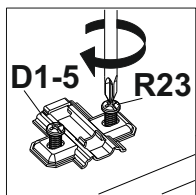
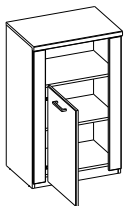
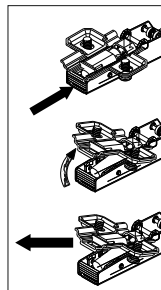

E15+D1-5



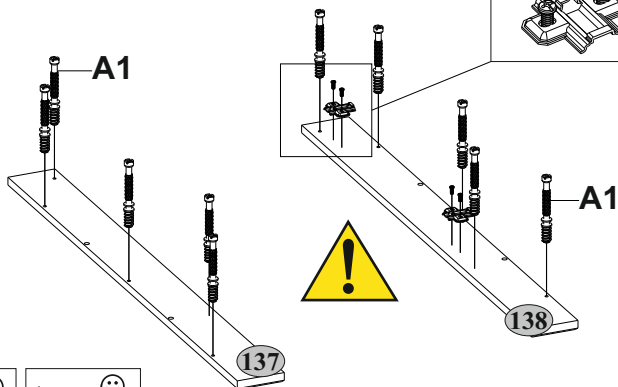
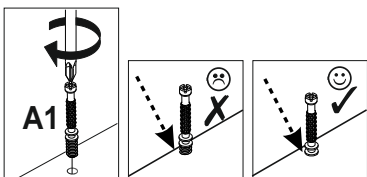
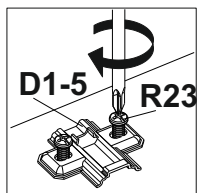
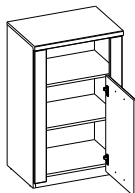

B

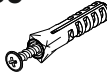

10

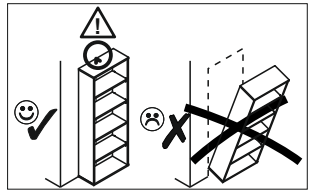
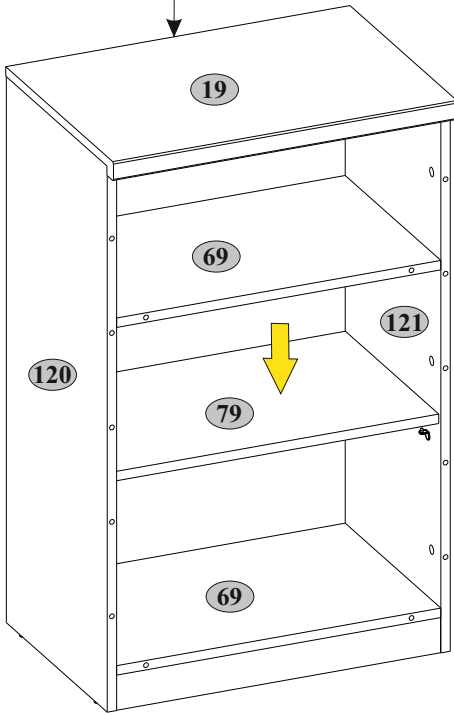
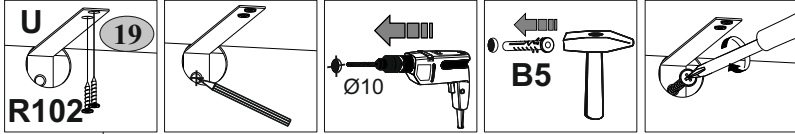
B5  10x50	U  130x35x15	R102  3,5x16
1	1	2



69	79	 max. 5 kg
19		 max. 15 kg

11**E15**

2

H58

1

R32

4x27

R102

2

3,5x16

S11

4

Ø8

2

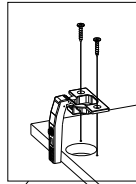
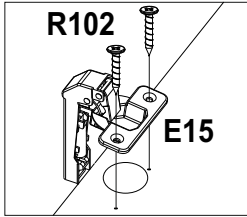
A**S11**

224

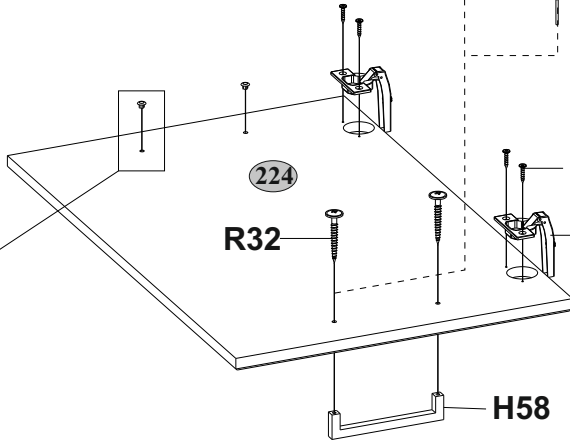
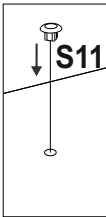
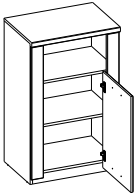
R32**H58****B**

Ø5

224

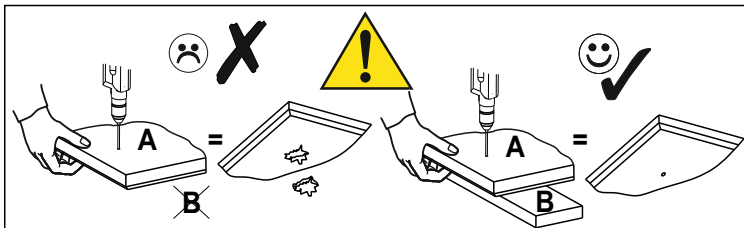
R102**R32****E15****H58**

12

A

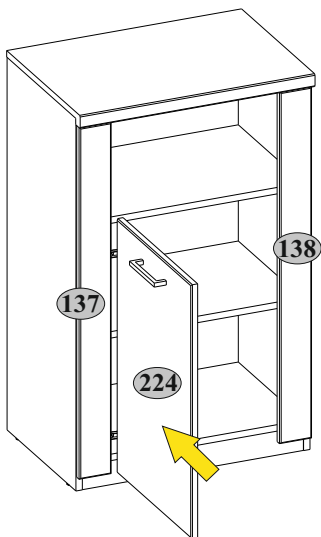
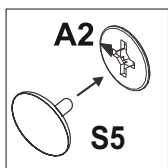
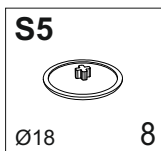
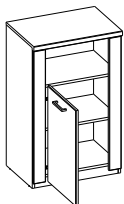

B

